

STANDARD CARTRIDGE SEALS

Installation, Operation & Maintenance Instructions

1. Foreword

This instruction manual contains standard, generic data and should be used with the seal family installation instructions. These instructions must be read and applied whenever work is done on the seal and must be kept available for future reference.

ATTENTION These instructions are for the installation and operation of a seal as used in rotating equipment. The instructions will help to avoid danger and increase reliability. The information required may change with other types of equipment or installation arrangements. This manual must be read in conjunction with the instruction manuals for both the pump and any ancillary equipment.

If the seal is to be used for an application other than that originally intended or outside the recommended performance limits, John Crane must be contacted before its installation and use.

Any warranty may be affected by improper handling, installation or use of this seal. Contact John Crane for information as to exclusive product warranty and limitations of liability.

If questions or problems arise, contact your local John Crane representative or the original equipment manufacturer, as appropriate.

ATTENTION John Crane mechanical seals are precision products and must be handled appropriately. Take particular care to avoid damage to lapped sealing faces and to flexible sealing rings. Do not excessively compress the seal before or during installation.

2. Safety

2.1 Warning symbols

The following designations are used in the installation instructions to highlight instructions of particular importance.



Danger
Mandatory instructions designed to prevent personal injury or extensive damage.

ATTENTION Special instructions or information to avoid damage to the system or its surroundings.

NOTE Information for easy installation and efficient operation.



Environmental note

2.2 Safety instructions



ATTENTION

1. Installation, removal and maintenance of the seal must be carried out only by qualified personnel who have read and understood these installation instructions.
2. The seal is designed exclusively for sealing rotating shafts. The manufacturer cannot be held liable for use of the seal for purposes other than this.

3. The seal must only be used in technically perfect condition, and must be operated within the recommended performance limits in accordance with its designated use and the instructions set out in these instructions.
4. If the pumped fluid is hazardous or toxic, appropriate precautions must be taken to ensure that any seal leakage is adequately contained. Further information on sealing hazardous or toxic fluids should be obtained from John Crane prior to seal installation.
5. Fluorocarbon components should never be burned or incinerated as the fumes and residues are highly toxic. If fluorocarbons are accidentally heated above 400°C/750°F, they can decompose. Protective gloves should be worn as hydrofluoric acid may be present.
6. PTFE components should never be burned or incinerated as the fumes are highly toxic.

2.3 Environmental aspects

2.3.1 Company policy extract

"It is the policy of John Crane to manage its business activities in an environmentally responsible manner, comply with all relevant laws and regulations, prevent pollution, and continually improve its environmental performance, certification to the latest issue of ISO 14001 ensures compliance."



John Crane adopts the 'Design For the Environment' (DFE) principle in making this product. Using this product will benefit the environment **directly** by:

- **Reducing waste** of precious resources through decreasing the risk of leakage and minimizing energy consumption
- **Preventing pollution** through controlling harmful emissions to the atmosphere and ground contamination
- **Preserving valuable materials** through the use of high quality durable materials.

2.3.2 Recycling

Product refurbishment

This product has been designed for long life.

Disposal

When the product is considered to be beyond economical repair and potential reuse, it should be disposed of by **environmentally beneficial** means. The product can be disassembled with ease.

Scrapped components

These should be handled with extra care due to possible contamination. They should be **recycled** through **local** industrial recycling plants.

Packaging

All packaging materials used are made from **recyclable**, environmentally friendly materials.

When in doubt or for further information and advice on this subject, please consult **John Crane**.

3. Hazardous Environments



Every working practice which compromises safety must be avoided.

STANDARD CARTRIDGE SEALS

Installation, Operation & Maintenance Instructions

In the event of an operating problem the machine must be switched off immediately and made safe! Problems must be solved promptly.

Minor emissions will occur during normal seal operation. Depending on the duty, this emission can appear as a gas, a liquid or a solid. For emissions that are hazardous or toxic and a safe collection system is required.

Hot surfaces have to be protected against accidental contact.

In order to avoid unforeseen hazards do not make unauthorised changes to the sealed fluid, the specific duty or the seal parts.

Some mechanical seals are used in conjunction with an ancillary support system; this is clarified either by the flush plan description on the seal arrangement drawing or by contacting John Crane (also see Section 10). It is important for the safe function of the seal that the support system is assembled and incorporated into the machine before operation. This manual should be read in conjunction with the appropriate documentation for auxiliary systems and rotating machinery.



Alarm systems are often included in the ancillary support system and the operator must ensure appropriate action is taken promptly in the event of an alarm.

Maintenance with steel tools must be avoided in the presence of substances classed as explosive group IIc according to EN 60079-0:2012+A11:2013.

If the machine is being used in a EN 60079-0:2012+A11:2013 Zone 21 or 22, regular cleaning of dust from exterior surfaces is required.

4. Declaration of Incorporation (2006/42/EC)

For each standard product supplied into the EU a Technical File is required and a Technical Record Sheet, satisfying the needs of 2006/42/EC. When requested, a Declaration of Incorporation (for which a Technical File exists) will be raised and signed by a John Crane appointed representative.

5. Transportation and Storage

Transport and store the seal in its original packaging. To ensure seals remain in good condition they should be stored in the following environment:

1. Dry and dust-free
2. Ventilated at room temperature
3. Protected from direct effects of heat and ultraviolet light
4. All the elastomers used in the mechanical seal have a minimum shelf life of 5 years except for butyl rubber which has a minimum shelf life of 2 years. We recommend that the elastomers be replaced at these intervals. It is also recommended that the elastomer replacement be carried out by John Crane personnel.



If used seal parts are to be shipped they must be cleaned and decontaminated before shipping. It is the responsibility of the machine user to ensure that any parts being shipped have appropriate safe-handling instructions externally attached to the package. Without

this information there will be a refusal to handle the goods. If required a decontamination/transportation certificate is available from John Crane. Refer to document EDS1001.

For additional information on transportation and storage, contact your local John Crane facility and request a copy of document I-Storage.

If any machine with an installed component seal has been stored with preservatives, before putting it back into operation the seal must be removed, cleaned and dried. Particular attention must be applied to the cleanliness of the faces and condition of the elastomers. For an installed cartridge seal we recommend returning the complete cartridge to John Crane for cleaning.

ATTENTION Ensure preservatives and cleaning agents do not affect the elastomers.

ATTENTION Once the seal is fitted on the machine and the position is set using setting devices do not re-engage them for transportation and storage.

6. Seal Installation

Refer to the appropriate seal family installation instructions. Do not excessively compress the seal before or during installation.

7. Before Starting the Equipment

1. Check the machine at the coupling for proper alignment of the driver or motor.
2. Ensure that the gland plate nuts/bolts are securely tightened according to the pump manual instructions, and all screws are securely fastened.
3. Assemble the machine, ensure any setting spacers are removed from the seal and turn the shaft (by hand if possible) to ensure free rotation.
4. Consult all available equipment operating instructions to check for correctness of all piping and connections, particularly regarding seal recirculation/flush, heating or cooling requirements, and services external to the seal. See Section 10. Ensure all unused ports are correctly plugged.

ATTENTION This mechanical seal is designed to operate in a liquid, so the heat energy it creates is adequately removed. The following check should be carried out not only after seal installation, but also after any period of equipment inactivity.

5. Check that the seal chamber fluid lines are open and free of any obstruction, and ensure that the seal chamber is properly vented and filled with liquid — refer to the pump instruction manual.

ATTENTION Except for dry running or gas lubricated seals which are designed to operate without liquid, wet seals that are operated without adequate liquid lubrication will often give rise to a squealing noise from the seal area and result in overheating and scoring or other damage to the sealing surfaces, causing excessive emissions and a reduced seal life.

STANDARD CARTRIDGE SEALS

Installation, Operation & Maintenance Instructions



Before start-up, ensure that all personnel and assembly equipment have been moved to a safe distance so there is no contact with rotating parts on the pump, seal, coupling or motor.

Seal installation should be handled only by qualified personnel. If questions arise, contact the local John Crane representative. Improper use and/or installation of this product could result in injury to the person and/or harmful emissions to the environment, and may affect any warranty on the product. Please contact the company for information as to exclusive product warranty and limitations of liability.

8. Maintenance

During operation, periodic visual external inspection of the seal should be carried out. A measure of seal condition is the level of emission of the process or barrier fluid and as no maintenance is possible while installed, the seal should be replaced when emissions become unacceptable. It is recommended that a spare seal be held in inventory to allow immediate replacement of a removed seal.

ATTENTION Machine adjustments that involve axial movement of the shaft may cause damage to the seal while installed.

Before attempting impeller clearance adjustment with a cartridge seal, refit the spacers then loosen all the drive collar socket set screws. With the shaft in its new working position, tighten with new socket set screws and remove the spacers. Keep the spacers for future use.

For a component seal (non-cartridge), remove the seal, adjust the impeller clearance then re-fit the seal at its correct working length.

8.1 Decommissioning the equipment

Ensure that the machine is made safe to work on by using a secured isolation under the sole control of the person(s) working on the machine and which includes the following:

- The driver is fully isolated from the machine using an appropriate, secured isolation method;
- Any pressure is safely and fully released;
- Any liquid is safely drained;
- Any gas safely vented;
- Any chemicals are safely and fully removed;
- Any other energy storage is safely and fully released;
- The isolation is proved to be effective at the point of work before work is commenced.



If the machine has been used on toxic or hazardous fluids, ensure that the machine is correctly decontaminated and made safe prior to commencing work. Remember that fluid is often trapped during draining and may be present inside the seal chamber. The machine instruction manual should be consulted to check for any special precautions.

8.2 Removing the seal

NOTE Remove from the machine with care, the seal may be suitable for reconditioning after service, if otherwise undamaged.

1. Referring to the machine instruction manual, dismantle the machine sufficiently to expose the seal and the seal housing.

ATTENTION For a cartridge seal, the setting spacers must be refitted before starting the removal procedure.

2. Deburr, clean and lubricate the shaft over which the seal will pass and remove the seal unit in the reverse order to installation.

A mechanical seal must always be serviced after removal from the machine. In order to maximise reliability and minimise safety risks, it is strongly recommended that used seals are returned to John Crane for rebuilding to as-new specification (essential for non-contacting gas seals). Alternatively ask for John Crane service personnel to visit site. For seal dismantling and assembly instructions, refer to John Crane.

See "Transportation and Storage" section regarding shipping.

NOTE It is recommended that a low pressure integrity test is carried out after repair and before installation on the machine.

8.3 Spare parts

Only John Crane spare parts should be used to recondition seals.

It is advisable to stock on site sufficient spare seal cartridges or the replacement parts shown on the installation drawing or as advised by John Crane to allow immediate replacement of the seal in the machine. The order codes for spare parts can be found in the parts list on the installation drawing or from John Crane directly. In the case of non-contacting gas seals, only complete cartridges should be stored.

The following data is necessary for spare part orders:

- Part number
- Quantity

9. Quality Assurance

This seal has been assembled in accordance with John Crane Quality Assurance Standards and with proper machine maintenance and use will give safe and reliable operation to the maximum recommended performance as shown in any relevant approved John Crane publication.

10. Mechanical Seal Piping Plans

To create the optimum environment for the mechanical seal it is usually necessary to add piping and sometimes extra equipment.

For advice on a specific application please contact John Crane.

For liquid lubricated seals, venting of air trapped around the seal faces is essential for correct seal operation. For horizontal machines the best method of automatically achieving this is a piping connection at top dead center (TDC). For vertical machines a piping connection above the seal faces is required.

STANDARD CARTRIDGE SEALS

Installation, Operation & Maintenance Instructions

11. Website

These instructions and other seal information can be found at www.johncrane.com.

12. Fitting Lubricants

Elastomers and PTFE	Lubricant
General applications	Soft hand soap/water solution, glycerine (glycerol)
Food, pharmaceutical or similar	Consult machine manufacturer

NOTE Always use a lubricant that is compatible with the machine and any ancillary machine and sealed product. Use lubricant sparingly.

Introduction

This document covers fitting of the mechanical seal to rotating machinery and should be kept for future reference. It should be used with any instruction manuals supplied with the rotating machinery and any ancillary equipment.

The mechanical seal contains precision lapped components which have been designed to minimize process fluid emissions when selected, fitted and used correctly.



If the process fluid is toxic or hazardous, appropriate precautions must be taken to contain any emissions.

Never burn any of the rubber or plastic parts of the mechanical seal. Toxic fumes may be generated.

ATTENTION The machinery operating conditions must not exceed the published operating limits of the mechanical seal.

ATTENTION Take care when handling the mechanical seal as it contains precision lapped parts.

NOTE Operating limits and all dimensions can be found at: www.johncrane.com.

The operating limits will depend on the materials used.

**TABLE 1. Socket Set Screw Tightening Torque
All Except 5600 Series**

Screw Size	Torque (lubricated) Nm/lbf-ft	Screw Size	Torque (lubricated) Nm/lbf-ft
M5	3.0/2.2	1/4-20 UNC	7.9/5.8
M6	4.0/3.0	5/6-18 UNC	14.7/10.8
M8	11.0/8.1	3/8-18 UNC	26.0/19.2

**TABLE 2. Socket Set Screw Tightening Torque
5600 Series Only**

Seal Size Code	Screw Size	Torque Nm/lbf-ft	Screw Size	Torque Nm/lbf-ft
Up to 0480	M5	3.5/2.6	#10-24 UNC	3.0/2.2
0500 to 1206	M6	7.0/5.2	1/4-20 UNC	8.0/5.9
1250 and above	M8	15.0/11.1	5/16-18 UNC	15.0/11.1

STANDARD CARTRIDGE SEALS

Installation, Operation & Maintenance Instructions

Checking the Machine

- A – Seal size
- B – 0.2-0.5 μm Ra
8-20 pinch Ra
- C – 1.6-3.2 μm Ra
63-125 pinch Ra
- D – 1.0 mm/0.040 inch
- E – 1.5 mm/0.060 inch

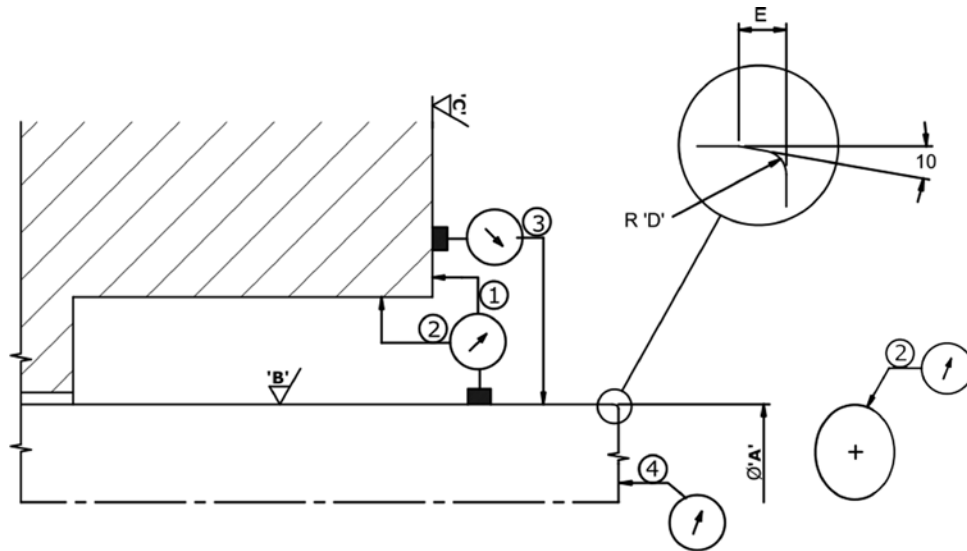

1	2	3	4
Squareness of shaft to seal chamber face	Concentricity seal chamber bore to shaft	Shaft runout	Shaft end play
0.001 mm/mm diameter 0.001 inch/inch diameter	<0.13 mm FIM <0.005 inch/FIM	<0.05 mm FM <0.002 inch/FIM	<0.13 mm FIM <0.005 inch/FIM

Installation Instructions

Before installing the mechanical seal read the instructions carefully. Keep for future use. Seal installation must only be carried out by a suitably qualified person.

1. Check that the machine is clean and meets the fitting tolerances shown in the figure above. (Misalignment can lead to excessive friction on the PTFE centering device on 4610, 4620, EZ-1 and 4615 range).
2. Unpack cartridge, inspect for damage, wipe clean.
3. Lubricate the machine shaft or sleeve with a recommended lubricant. See Recommended Properties of Barrier Liquids for Dual Seals, page 9.
4. Slide the cartridge on to the machine shaft or sleeve and rotate until the barrier inlet port ports are in a suitable position for flush piping.
5. Ensure that gland plate sealing ring is in position then slide the cartridge against the seal chamber.
6. Fit the gland plate fasteners and evenly tighten to the torque recommended by the machine manufacturer.
7. Ensure the machine shaft is locked axially in its final correct position and evenly tighten the cartridge drive collar socket set screws. See Table 1 or Table 2 depending on cartridge type for torque values.
8. Remove any setting clips or spacers and store for future use in cartridge removal. For EZ-1, 4610, 4615 and most 4620P seals there are no setting clips to remove.
9. Turn the machine shaft by hand if possible to ensure free rotation with no shaft binding.
10. Complete the required piping to the seal. See pages 6 and 7. Take care not to use excessive thread sealant when making circulation pipe work connections. Unused tapped connections must be safely plugged before seal operation.
11. Ensure machine seal chamber and seal are safely vented before starting the machine. This should be achieved through self-venting pipework. When manual vents are necessary they must be installed and used safely.
12. For liquid lubricated dual seals ensure that the seal lubrication system is correctly filled with suitable liquid. See Recommended Properties of Barrier Liquids for Dual Seals on page 9 for guidance on liquid selection.
13. For a dual pressurized arrangement ensure that the seal is pressurized to a minimum of 1bar above the maximum machine seal chamber pressure before the machine is pressurized. The seal pressure must be within the seal and seal lubrication system operating pressure.

Once fitted, no adjustment is possible during the life of the mechanical seal. When the mechanical seal requires replacement, John Crane can supply a new or reconditioned seal to the original specification.

STANDARD CARTRIDGE SEALS

Installation, Operation & Maintenance Instructions

Typical Flush Piping for Single Seals

Plan 11 – commonly used with single seals on horizontal shafts

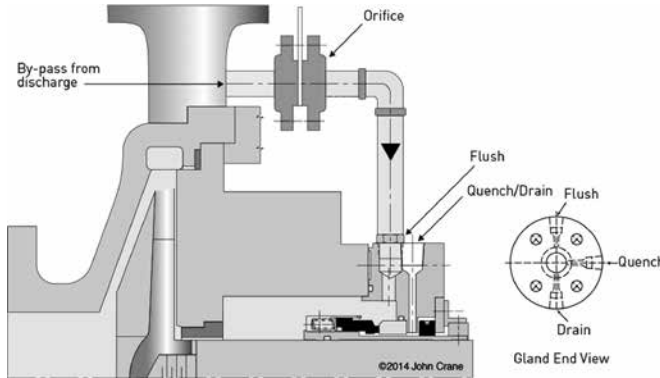

Quench optional

Plan 13 – commonly used with single seals on vertical shafts

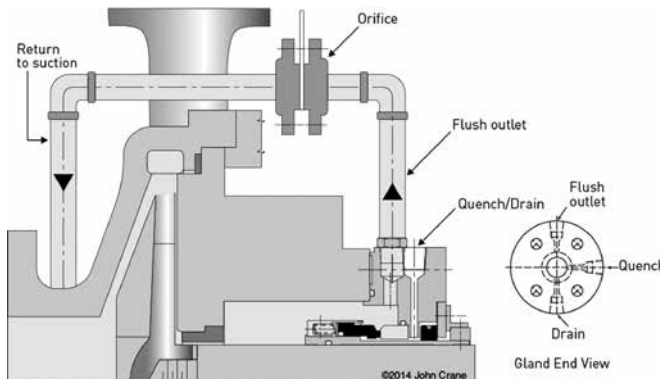

Quench optional

Plan 23 – commonly used with hot processes

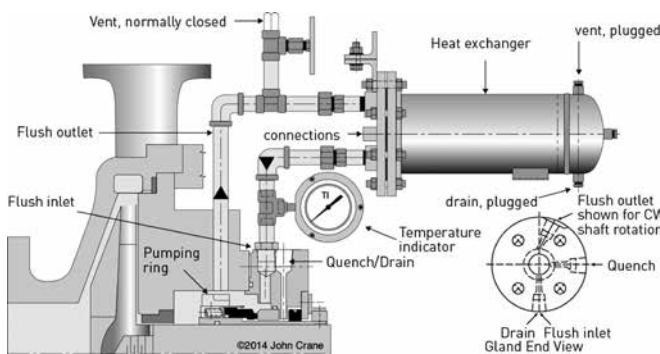

Quench optional

Plan 62 – quench schematic

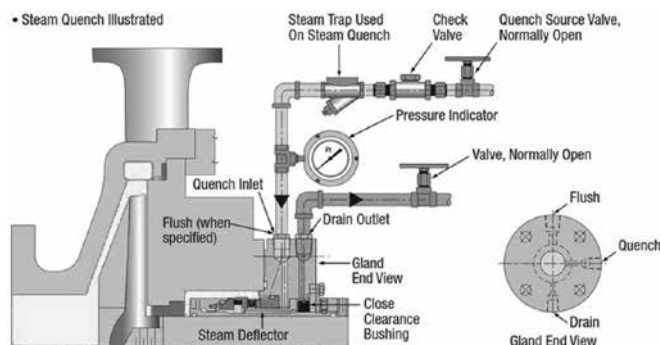

Typical Seal Cross Section

Type 5610

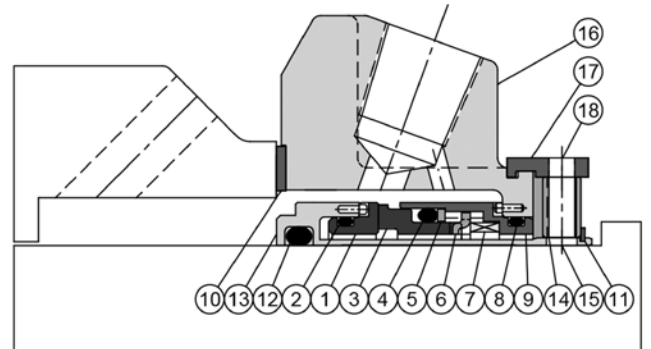

- 1 – Mating ring
- 2 – O-ring
- 3 – Primary ring
- 4 – O-ring
- 5 – Anti-extrusion ring
- 6 – Drive ring
- 7 – Spring
- 8 – O-ring
- 9 – Retainer
- 10 – Gasket
- 11 – Snap ring
- 12 – O-ring
- 13 – Sleeve assembly
- 14 – Collar
- 15 – Set screw
- 16 – Gland plate assembly
- 17 – Spacer
- 18 – Socket head cap screw

Type 5620

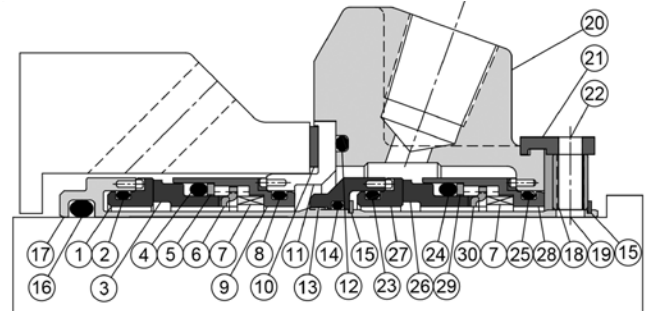

- 1 – Mating ring
- 2 – O-ring
- 3 – Primary ring
- 4 – O-ring
- 5 – Anti-extrusion ring
- 6 – Drive ring
- 7 – Spring
- 8 – O-ring
- 9 – Retainer
- 10 – Gasket
- 11 – Gland adapter assembly
- 12 – O-ring
- 13 – Sleeve adaptor
- 14 – O-ring
- 15 – Snap ring
- 16 – O-ring
- 17 – Sleeve assembly
- 18 – Collar
- 19 – Set screw
- 20 – Gland plate assembly
- 21 – Spacer
- 22 – Socket head cap screw
- 23 – O-ring
- 24 – O-ring
- 25 – O-ring
- 26 – Primary ring
- 27 – Mating ring
- 28 – Retainer
- 29 – Anti-extrusion ring
- 30 – Drive ring

STANDARD CARTRIDGE SEALS

Installation, Operation & Maintenance Instructions

Series Gland Installation Guide

Piping connections

A cast gland plate is normally used up to shaft sizes 3.000 inch/75 mm. A letter identifying the function may be marked on the blank pads as follows:

- | | |
|-------------------|----------------------------------|
| D – Drain | I – Buffer/barrier inlet |
| F – Flush | O – Buffer/barrier outlet |
| Q – Quench | V – Vent |

All standard pipework connections are tapped 3/8 inch NPT.

Special 5610 and 5615 seals may use a dual seal gland plate with a single seal, for conical seal chambers. All ports are plugged. Use no flush. A quench bush allows a quench by piping ports 1 and 3 as shown for "Single Seal with Quench".

Seal sizes above 75 mm/3.000 inch use a fully machined gland plate with radial drillings that allow bi-directional shaft rotation. Pipework connections are tapped 1/2 inch NPT.

ATTENTION Some gland plates will have unused connections sealed with metal plugs.

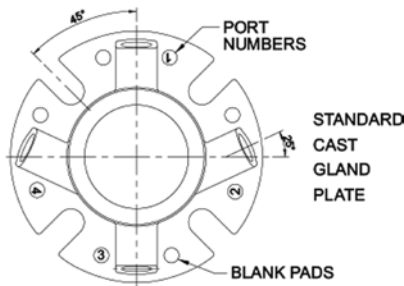

As supplied, these gland plates have metal plugs fitted as follows:

Inch sizes – see relevant clockwise ANSI pump illustrations

mm sizes – see relevant clockwise DIN pump illustrations

Remaining connections are fitted with temporary plastic blanking plugs that cannot hold pressure. All plugs should be left in place until connection of the pipework. Plastic plugs must be replaced with metal plugs or appropriate fittings.

NOTE Ensure the seal is correctly piped and plugged as shown in the relevant illustration for the particular application. Due to the wide variety of design of pumps and other machines the piping illustrations may not be valid in all cases. Consult John Crane if an alternative piping arrangement is required.

Sizes to 75 mm/3.000 inch DIN Pumps Clockwise Rotation

Single seal with flush

Single seal with quench

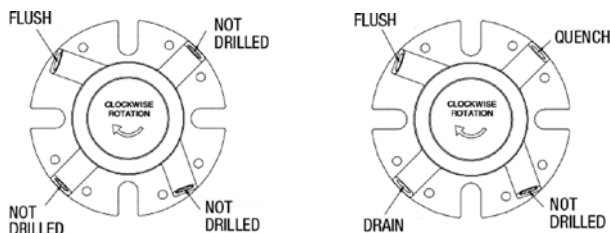

Dual seal preferred arrangement

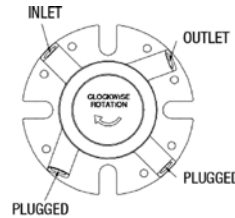

Dual seal optional arrangement

NO OPTION AVAILABLE

Sizes to 75 mm/3.000 inch ANSI Pumps Clockwise Rotation

Single seal with flush

Single seal with quench

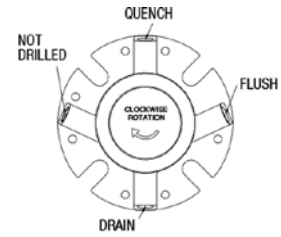
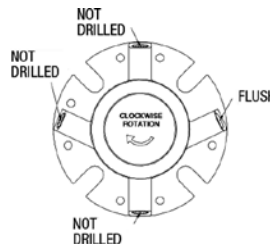

Dual seal preferred arrangement

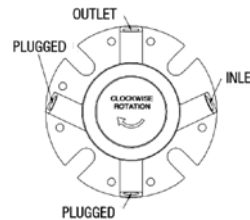

Dual seal optional arrangement

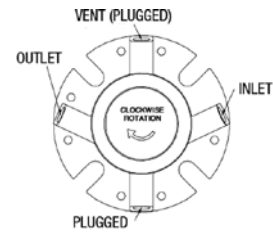

Sizes to 75 mm/3.000 inch DIN Pumps Counter Clockwise Rotation

Single seal with flush

Single seal with quench

Dual seal

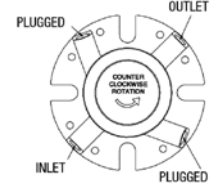
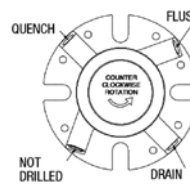
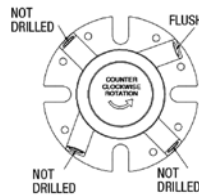

Sizes to 75 mm/3.000 inch ANSI Pumps Counter Clockwise Rotation

Single seal with flush

Single seal with quench

Dual seal

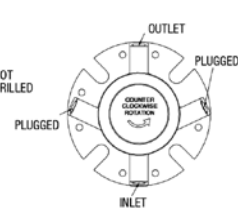
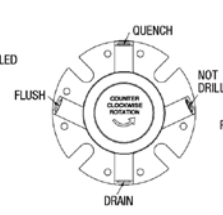
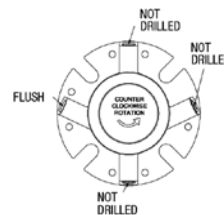

Sizes Over 75 mm/3.000 inch ANSI Pumps Bi-directional Rotation

Single seal with flush

Single seal with quench

Dual seal

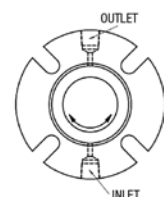
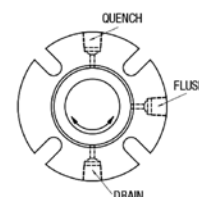
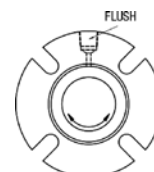

STANDARD CARTRIDGE SEALS

Installation, Operation & Maintenance Instructions

- For dual seals on a vertical shaft the barrier outlet should be above the upper seal faces to ensure self-venting. The flush connection should be above the level of the lower faces.
- For a thermosiphon system, follow the piping layout on page 8. A pumping ring is always recommended for use with a thermosiphon system.

Notes

- In a dual unpressurized arrangement the inboard seal is cooled and lubricated by the pumped liquid at seal chamber pressure. The outboard seal is lubricated by the barrier liquid typically at atmospheric or flare pressure.
- In a dual pressurized arrangement both seals are cooled and lubricated by the barrier liquid maintained at a pressure higher than the seal chamber pressure. This arrangement isolates the pumped liquid from the atmosphere.

Alternative Terms for Gland Plate Ports

I, BI, LBI – Buffer/barrier inlet	Q – Quench
O, BO, LBO – Buffer/barrier outlet	F – Flush
D – Drain	H – Heating (applies to jacket when fitted)
V – Vent	C – Cooling (applies to jacket when fitted)

Recommended Properties of Barrier Liquids for Dual Seals

- A good lubricant with good heat transfer properties
- Clean
- Compatible with the process fluid and seal materials of construction
- Stable over the seal's operating range
- Non-hazardous
- A viscosity < 15 cSt/80 SSU @ 40°C/104°F and ideally between 1 and 10 cSt/31 to 60 SSU @ 65°C/150°F
- A maximum viscosity of 680 SSU/150 cSt at the minimum ambient temperature

Seal Dimensions

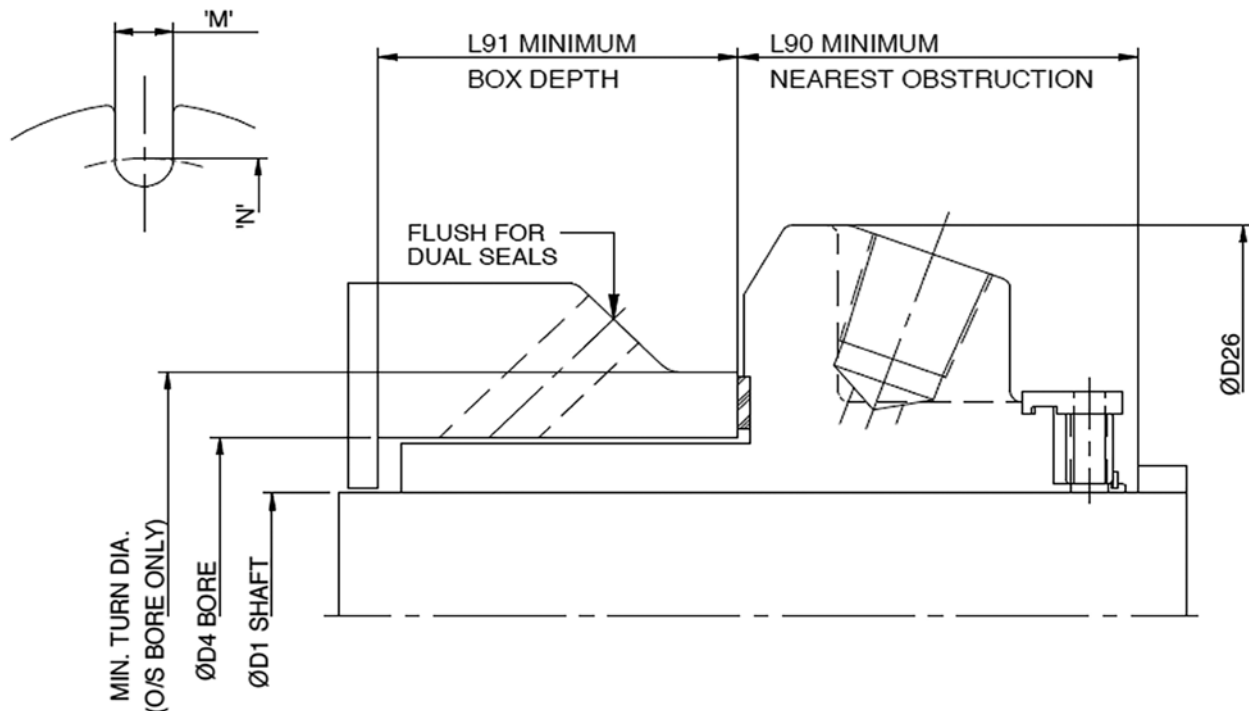

STANDARD CARTRIDGE SEALS

Installation, Operation & Maintenance Instructions

Large Bore Dimensional Data (Millimeters)

D1 Shaft Seal Size	5610, 5610D, 5610V, 5615								5610L, 5610Q, 5610VL, 5610VQ, 5615L, 5615Q								5611								5611L, 5611Q								5620, 5620P, 5620VD, 5620VP, 5625, 5625P							
	D4		D26	L90	L91	M	N	Turn Dia	D4		D26	L90	L91	M	N	Turn Dia	D4		D26	L90	L91	M	N	Turn Dia	D4		D26	L90	L91	M	N	Turn Dia	D4		D26	L90	L91	M	N	Turn Dia
	min	max			min	min	min		min	max			min		min	min	min	max			min		min	min	min	max			min	min	min	min	max			min	min	min		
34.9	73.0	76.8	136.5	54.0	6.4	14.3	103.2	83.0	73.0	76.8	136.5	54.0	20.1	14.3	103.2	83.0	73.0	76.8	136.5	54.0	17.5	14.3	103.2	83.0	73.0	76.8	136.5	54.0	34.4	14.3	103.2	83.0	73.0	76.8	136.5	54.0	48.6	14.3	103.2	83.0
44.5	88.9	99.7	165.1	55.5	6.4	17.4	129.4	98.7	88.9	99.7	165.1	55.5	18.9	17.4	129.4	98.7	88.9	99.7	165.1	55.5	26.4	17.4	129.4	98.7	88.9	99.7	165.1	55.5	41.3	17.4	129.4	98.7	88.9	99.7	165.1	55.5	50.7	17.4	129.4	98.7
47.6	92.1	94.8	165.1	51.2	8.3	17.4	129.4	*	92.1	94.8	165.1	51.2	23.2	17.4	129.4	*	92.1	94.8	165.1	51.2	30.7	17.4	129.4*	**	92.1	94.8	165.1	51.2	45.6	17.4	129.4	*	92.1	94.8	165.1	55.5	50.7	17.4	129.4	101.8
54.0	98.4	108.0	184.2	61.1	5.6	17.4	144.4	108.3	98.4	108.0	181.8	61.1	20.5	17.4	144.4	108.3	98.4	108.0	181.8	61.1	7.5	17.4	144.4	108.3	98.4	108.0	181.8	61.1	47.9	17.4	144.4	108.3	98.4	108.0	184.2	61.1	55.8	17.4	144.4	108.3
63.5	120.7	129.0	203.2	66.7	5.2	17.4	154.0	130.5	120.7	129.0	203.2	64.3	17.7	17.4	154.0	127.0	120.7	123.8	203.2	64.3	39.3	17.4	154.0	130.5	120.7	123.8	203.2	64.3	51.9	17.4	154.0	130.5	120.7	129.0	203.2	64.3	53.5	17.4	154.0	127.0
66.7	117.5	120.4	203.2	62.3	7.5	17.4	154.0	**	117.5	120.4	203.2	62.3	22.5	17.4	154.0	**	117.5	120.4	203.2	62.3	45.1	17.4	154.0	***	117.5	120.4	203.2	62.3	60.0	17.4	154.0	**	117.5	120.4	203.2	65.1	56.4	17.4	154.0	127.0
69.9	120.7	123.8	203.2	64.3	5.5	17.4	154.0	130.5	120.7	123.8	203.2	64.3	20.5	17.4	154.0	130.5	120.7	123.8	203.2	64.3	43.1	17.4	154.0	130.5	120.7	123.8	203.2	64.3	58.0	17.4	154.0	130.5	120.7	123.8	203.2	64.3	58.7	17.4	154.0	130.5

*Seal cartridge is OD registered on the Turn Dia. of 104.8.

**Seal cartridge is OD registered on the Turn Dia. of 130.2.

STANDARD CARTRIDGE SEALS

Installation, Operation & Maintenance Instructions

Standard Bore Dimensional Data (Inches)

D1 Size	4610							4620P							5610, 5610D, 5610V, 5615							5610L, 5610Q, 5610VL, 5610VQ, 5615L, 5615Q							5611						5611L, 5611Q								
	D4		D26	L90	L91	M	N	D4		D26	L90	L91	M	N	D4		D26	L90	L91	M	N	D4		D26	L90	L91	M	N	D4		D26	L90	L91	M	N	D4		D26	L90	L91	M	N	
	min	max		min	min	min	min	min	max					min	min	max					min	min	max				min	min	max				min	min	max				min	min	max		
1.000	1.615	1.940	4.125	1.476	1.260	0.437	2.620	1.625	1.889	4.000	2.000	1.635	0.525	2.800	1.445	1.889	4.000	2.000	0.160	0.525	2.805	1.625	1.889	4.000	2.000	0.746	0.525	2.805	1.500	1.889	4.000	2.000	0.910	0.525	2.805	1.625	1.889	4.000	2.000	1.498	0.525	2.805	
1.125	1.730	2.060	4.250	1.476	1.260	0.437	2.750	1.75	2.015	4.125	2.125	1.603	0.525	2.930	N/A	2.015	4.125	2.125	0.125	0.525	2.933	1.750	2.015	4.125	2.125	0.714	0.525	2.933	1.625	2.015	4.125	2.125	0.658	0.525	2.933	1.750	2.015	4.125	2.125	1.246	0.525	2.933	
1.250	1.875	2.190	4.370	1.476	1.260	0.437	2.870	1.875	2.294	4.25	2.125	1.603	0.525	3.210	N/A	2.294	4.250	2.125	0.125	0.525	3.213	1.875	2.294	4.250	2.125	0.791	0.525	3.213	1.812	2.294	4.250	2.125	0.781	0.525	3.213	1.875	2.294	4.250	2.125	1.453	0.525	3.213	
1.375	2.000	2.310	4.500	1.476	1.260	0.437	3.060	2.000	2.421	4.375	2.125	1.603	0.525	3.340	N/A	2.421	4.375	2.125	0.125	0.525	3.338	2.000	2.421	4.375	2.125	0.791	0.525	3.338	1.937	2.421	4.375	2.125	0.688	0.525	3.338	2.000	2.421	4.375	2.125	1.353	0.525	3.338	
1.500	2.250	2.500	5.000	1.516	1.299	0.563	3.430	2.25	2.68	4.875	2.187	1.68	0.525	3.600	2.007	2.680	4.875	2.187	0.156	0.525	3.599	2.250	2.680	4.875	2.187	0.744	0.525	3.599	2.125	2.680	4.875	2.187	0.960	0.525	3.599	2.218	2.680	4.875	2.187	1.548	0.525	3.599	
1.625	2.360	2.500	5.000	1.516	1.299	0.563	3.430	2.375	2.812	5.000	2.187	1.68	0.525	3.770	2.132	2.812	5.000	2.187	0.156	0.562	3.766	2.375	2.812	5.000	2.187	0.744	0.562	3.766	2.250	2.812	5.000	2.187	1.022	0.562	3.766	2.343	2.812	5.000	2.187	1.610	0.562	3.766	
1.750	2.500	2.625	5.250	1.516	1.299	0.563	3.560	2.500	2.918	5.250	2.187	1.68	0.562	3.810	2.240	2.918	5.250	2.187	0.156	0.562	3.875	2.480	2.918	5.250	2.187	0.744	0.562	3.875	2.375	2.918	5.250	2.187	1.038	0.562	3.875	2.480	2.918	5.250	2.187	1.626	0.562	3.875	
1.875	2.625	3.000	5.500	1.516	1.299	0.563	3.870	2.625	2.918	5.250	2.187	1.68	0.562	3.870	2.382	2.918	5.250	2.187	0.156	0.562	3.875	2.625	2.918	5.250	2.187	0.744	0.562	3.875	2.500	2.918	5.250	2.187	1.038	0.562	3.875	2.625	2.918	5.250	2.187	1.626	0.562	3.875	
2.000	2.750	3.000	5.500	1.516	1.299	0.563	3.870	2.75	3.015	5.500	2.375	1.711	0.562	4.000	2.507	3.015	5.500	2.375	0.187	0.562	4.000	2.750	3.015	5.500	2.375	0.775	0.562	4.000	2.750	3.015	5.500	2.375	1.266	0.562	4.000	2.750	3.015	5.500	2.375	1.854	0.562	4.000	
2.125	2.875	3.310	5.750	1.516	1.299	0.563	4.370	2.875	3.36	5.859	2.375	1.711	0.687	4.470	2.632	3.360	5.859	2.375	0.187	0.687	4.469	2.875	3.360	5.859	2.375	0.775	0.687	4.469	2.875	3.360	5.859	2.375	1.266	0.687	4.469	2.875	3.360	5.859	2.375	1.854	0.687	4.469	
2.250	3.000	3.310	5.750	1.516	1.299	0.689	4.370	3.000	3.485	6.500	2.475	1.711	0.681	4.570	2.757	3.485	6.500	2.375	0.187	0.687	4.566	3.000	3.485	6.500	2.375	0.775	0.687	4.566	2.875	3.485	6.500	2.375	1.391	0.687	4.566	3.000	3.485	6.500	2.375	1.979	0.687	4.566	
2.375	3.130	3.560	6.000	1.516	1.299	0.689	4.620	3.125	3.61	6.500	2.528	1.711	0.681	4.720	2.882	3.610	6.500	2.528	0.143	0.687	4.719	3.125	3.610	6.500	2.528	0.722	0.687	4.719	3.125	3.610	6.500	2.528	1.127	0.687	4.719	3.125	3.610	6.500	2.528	1.783	0.687	4.719	
2.500	3.250	3.875	6.250	1.535	1.417	0.689	4.870	3.375	3.891	6.750	2.625	1.703	0.687	5.000	N/A	3.891	6.750	2.625	0.125	0.687	5.000	3.375	3.891	6.750	2.625	0.542	0.687	5.000	3.375	3.891	6.750	2.625	1.391	0.687	5.000	3.375	3.891	6.750	2.625	1.887	0.687	5.000	
2.625	3.500	3.875	6.250	1.535	1.417	0.689	4.870	3.687	4.052	6.750	2.562	1.727	0.687	5.170	N/A	4.062	6.750	2.562	0.125	0.687	5.170	3.625	4.062	6.750	2.562	0.713	0.687	5.170	3.625	4.062	6.750	2.562	1.603	0.687	5.170	3.625	4.062	6.750	2.562	2.191	0.687	5.170	
2.750	3.740	3.875	6.250	1.535	1.417	0.689	4.870	3.587	4.052	6.750	2.562	1.727	0.687	5.170	N/A	4.062	6.750	2.562	0.125	0.687	5.170	3.625	4.062	6.750	2.562	0.713	0.687	5.170	3.625	4.062	6.750	2.562	1.603	0.687	5.170	3.625	4.062	6.750	2.562	2.191	0.687	5.170	
2.875	4.000	4.500	8.110	1.811	1.673	0.811	5.710	3.812	4.186	7.000	2.562	1.727	0.687	5.312	N/A	4.186	7.000	2.562	0.125	0.687	5.312	3.687	4.186	7.000	2.562	0.713	0.687	5.312	3.695	4.186	7.000	2.562	1.603	0.687	5.312	3.695	4.186	7.000	2.562	2.203	0.687	5.312	
3.000	4.000	4.500	8.110	1.811	1.673	0.811	5.710	4.000	4.469	7.750	2.625	2.250	0.812	5.720	N/A	4.469	7.750	2.625	0.125	0.812	5.720	3.934	4.469	7.750	2.625	0.651	0.812	5.720	4.000	4.469	7.750	2.625	1.735	0.812	5.720	4.000	4.469	7.750	2.625	2.313	0.812	5.720	
3.125	4.252	4.748	8.110	1.811	1.673	0.811	5.940	4.125	4.600	7.875	2.687	2.250	0.812	5.845	3.853	4.600	7.875	2.687	0.125	0.812	5.845	4.125	4.600	7.875	2.687	0.719	0.812	5.845	4.125	4.600	7.875	2.687	1.750	0.812	5.845	4.125	4.600	7.875	2.687	2.344	0.812	5.845	
3.250	4.252	4.748	8.110	1.811	1.673	0.811	5.940	4.125	4.600	7.437	2.635	2.250	0.812	5.845	3.853	4.600	7.437	2.635	0.177	0.812	5.845	4.125	4.600	7.437	2.635	0.708	0.812	5.845	4.125	4.600	7.437	2.635	1.802	0.812	5.845	4.125	4.600	7.437	2.635	2.333	0.812	5.845	
3.375	4.370	4.874	8.110	1.811	1.673	0.811	6.060	4.375	4.850	8.125	2.687	2.250	0.812	6.095	4.125	4.850	8.125	2.687	0.125	0.812	6.095	4.375	4.850	8.125	2.687	0.719	0.812	6.095	4.375	4.850	8.125	2.687	1.938	0.812	6.095	4.375	4.850	8.125	2.687	2.532	0.812	6.095	
3.500	4.500	5.000	8.504	1.811	1.673	0.811	6.220	4.500	4.975	8.250	2.687	2.250	0.812	6.220	4.250	4.975	8.250	2.687	0.125	0.812	6.220	4.500	4.975	8.250	2.687	0.719	0.812	6.220	4.500	4.975	8.250	2.687	1.907	0.812	6.220	4.500	4.975	8.250	2.687	2.532	0.812	6.220	
3.625	4.626	5.118	8.504	1.811	1.673	0.811	6.300	4.625	5.100	8.375	2.687	2.250	0.688	6.250	4.343	5.100	8.375	2.687	0.125	0.687	6.250	4.625	5.100	8.375	2.687	0.719	0.687	6.250	4.625	5.100	8.375	2.687	2.188	0.687	6.250	4.625	5.100	8.375	2.687	2.781	0.687	6.250	
3.750	4.752	5.252	9.685	1.811	1.673	0.811	6.460	4.724	5.199	8.750	2.687	2.250	0.688	6.770	4.468	5.199	8.750	2.687	0.125	0.687	6.770	4.724	5.199	8.750	2.687	0.719	0.687	6.770	4.724	5.199	8.750	2.687	2.000	0.687	6.770	4.781	5.199	8.750	2.687	2.594	0.687	6.770	
3.875	4.874	5.374	9.685	1.811	1.673	0.811	6.570	4.875	5.375	8.750	2.687	2.250	0.812	6.636	4.593	5.375	8.750	2.687	0.125	0.812	6.636	4.875	5.375	8.750	2.687	0.719	0.812	6.636	4.905	5.375	8.750	2.687	2.063	0.812	6.636	4.968	5.375	8.750	2.687	2.656	0.812	6.636	
4.000	5.000	5.512	9.685	1.811	1.673	0.811	6.730	5.000	5.500	9.000	2.687	2.250	0.812	6.761	4.718	5.500	9.000	2.687	0.125	0.812	6.761	5.000	5.500	9.000	2.687	0.719	0.812	6.761	5.031	5.500	9.000	2.687	2.375	0.812	6.761	5.114	5.500	9.000	2.687	2.969	0.812	6.761	
4.125	5.252	5.906	9.685	2.441	1.732	0.811	7.130	5.125	5.625	9.000	2.687	2.250	0.812	6.886	4.843	5.625	9.000	2.687	0.125	0.812	6.886	5.125	5.625	9.000	2.687	0.719	0.812	6.886	-														

STANDARD CARTRIDGE SEALS

Installation, Operation & Maintenance Instructions

Large Bore Dimensional Data (Inches)

D1 Shaft Seal Size	5610, 5610D, 5610V, 5615							5610L, 5610Q, 5610VL, 5610VQ, 5615L, 5615Q							5611						5611L, 5611Q						5620, 5620P, 5620VD, 5620VP, 5625, 5625P													
	D4		D26	L90	L91	M	N	Turn Dia	D4		D26	L90	L91	M	N	Turn Dia	D4		D26	L90	L91	M	N	Turn Dia	D4		D26	L90	L91	M	N	Turn Dia								
	min	max			min	min	min		max			min	min	min	min		min	min	max			min	min		min	min	max			min	min		min	min						
1.375	2.875	3.023	5.375	2.125	0.250	0.562	4.062	3.268	2.875	3.023	5.375	2.125	0.791	0.562	4.062	3.268	2.875	3.023	5.375	2.125	0.688	0.562	4.062	3.268	2.875	3.023	5.375	2.125	1.353	0.562	4.062	3.268	2.875	3.023	5.375	2.125	1.914	0.562	4.062	3.268
1.750	3.500	3.925	6.500	2.187	0.250	0.687	5.093	3.885	3.500	3.925	6.500	2.187	0.744	0.687	5.093	3.885	3.500	3.925	6.500	2.187	1.038	0.687	5.093	3.885	3.500	3.925	6.500	2.187	1.626	0.687	5.093	3.885	3.500	3.925	6.500	2.187	1.995	0.687	5.093	3.885
1.875	3.625	3.734	6.500	2.017	0.327	0.687	5.093	*	3.625	3.734	6.500	2.017	0.915	0.687	5.093	*	3.625	3.734	6.500	2.017	1.209	0.687	5.093	**	3.625	3.734	6.500	2.017	1.797	0.687	5.093	*	3.625	3.734	6.500	2.187	1.995	0.687	5.093	4.006
2.125	3.875	4.250	7.250	2.407	0.219	0.687	5.687	4.264	3.875	4.250	7.156	2.407	0.806	0.687	5.687	4.264	3.875	4.250	7.156	2.407	0.297	0.687	5.687	4.264	3.875	4.250	7.156	2.407	1.885	0.687	5.687	4.264	3.875	4.250	7.250	2.407	2.198	0.687	5.687	4.264
2.500	4.750	5.078	8.000	2.625	0.204	0.687	6.062	5.139	4.750	5.078	8.000	2.532	0.698	0.687	6.062	5.000	4.750	4.875	8.000	2.532	1.547	0.687	6.062	5.139	4.750	4.875	8.000	2.532	2.043	0.687	6.062	5.139	4.750	5.078	8.000	2.532	2.107	0.687	6.062	5.000
2.625	4.625	4.740	8.000	2.454	0.296	0.687	6.062	**	4.625	4.740	8.000	2.454	0.884	0.687	6.062	**	4.625	4.740	8.000	2.454	1.774	0.687	6.062	***	4.625	4.740	8.000	2.454	2.362	0.687	6.062	**	4.625	4.740	8.000	2.562	2.219	0.687	6.062	5.000
2.750	4.750	4.875	8.000	2.532	0.218	0.687	6.062	5.139	4.750	4.875	8.000	2.532	0.806	0.687	6.062	5.139	4.750	4.875	8.000	2.532	1.696	0.687	6.062	5.139	4.750	4.875	8.000	2.532	2.284	0.687	6.062	5.139	4.750	4.875	8.000	2.532	2.312	0.687	6.062	5.139

*Seal cartridge is OD registered on the Turn Dia. of 4.125.
**Seal cartridge is OD registered on the Turn Dia. of 5.125.



North America
United States of America
Tel: 1-847-967-2400
Fax: 1-847-967-3915

Europe
United Kingdom
Tel: 44-1753-224000
Fax: 44-1753-224224

Latin America
Brazil
Tel: 55-11-3371-2500
Fax: 55-11-3371-2599

Middle East & Africa
United Arab Emirates
Tel: 971-481-27800
Fax: 971-488-62830

Asia Pacific
Singapore
Tel: 65-6518-1800
Fax: 65-6518-1803

If the products featured will be used in a potentially dangerous and/or hazardous process, your John Crane representative should be consulted prior to their selection and use. In the interest of continuous development, John Crane Companies reserve the right to alter designs and specifications without prior notice. It is dangerous to smoke while handling products made from PTFE. Old and new PTFE products must not be incinerated. ISO 9001 and ISO14001 Certified, details available on request.