



Product Description

The Type 10T and 10R seals are designed to use PTFE bellows and are for external mounting on extremely corrosive duties.

Design Features

- Non-pusher bellows feature eliminates sliding contact with the equipment shaft or sleeve during operation
- The outer-end of the seal bellows is clamped to the shaft or sleeve surface, and the bellows convolutions extend to compensate for seal face wear
- All surfaces contacting the liquid being sealed are made of chemically inert materials. Metallic components — springs and clamping ring — are located outside the pump stuffing box, isolated from the process liquid
- The Type 10T face is not replaceable, but the seal has a higher-duty pressure and transient pressure rating than the Type 10R
- The Type 10R seal face is replaceable and can be supplied in hard materials making the seal suitable for abrasive applications
- The seals incorporate visual wear indicators which show the initial seal setting and the amount of face wear while in service

Performance Capabilities

- Temperature: 45°C to +120°C/-50°F to +250°F
- Pressure: up to 13 bar g/185 psig
- Speed: up to 16 m/s/3150 fpm

Fluids

- Acids
- Organic compounds
- Salts

Design Features

Mechanical Drive Design

Prevents slippage on shaft or sleeve to eliminate galling and premature wear.

Replaceable Seal Face

The Type 10R seal has a replaceable face insert so that different face materials can be used to handle a wide range of corrosive and abrasive liquids.

Flexible PTFE Bellows Design

Maximum corrosion resistance. Eliminates the possibility of seal face misalignment. Compensates for shaft run-out to promote low-maintenance, long-life operation.

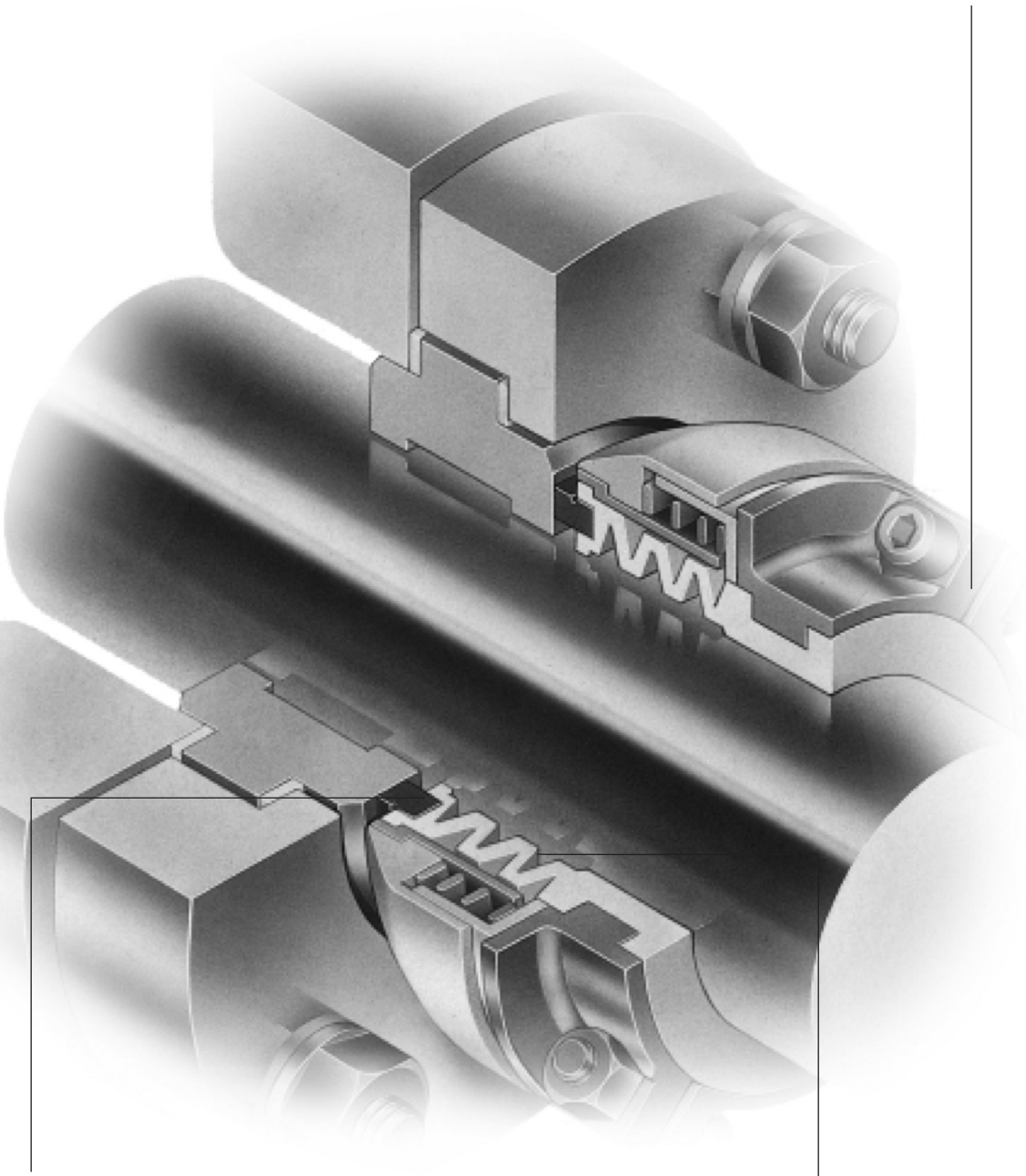

Type 10T and 10R Typical Arrangement

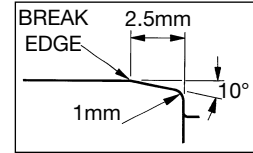
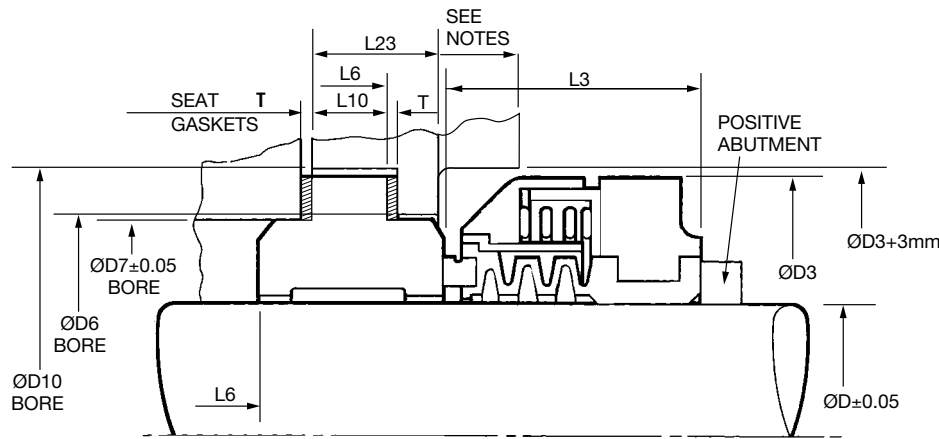

For ease of installation, the lead-in edge of the shaft or sleeve should be chamfered as shown.

D19=DIA. OF SWING OF CLAMP SCREWS

Type 10T and 10R Dimensional Data - Small Sizes (mm)

D (mm)	Seal Size Code (Metric)	D (Inch)	Seal Size Code (Inch)	Seat Size Code	D3	D6	D7	D10	D19	L3	L6	L10	L23	T
16	0160	0160	0190	0190	54	37.5	36.51	48	60	31	4.8	8.0*	14*	0.8
18	0180	0180	-	0190	54	37.5	36.51	48	60	31	4.8	8.0*	14*	0.8
20	0200	0200	0222	0222	57	40.5	39.69	51	64	31	4.8	8.0*	16*	0.8
22	0220	0220	-	0222	57	40.5	39.69	51	64	31	4.8	8.0*	16*	0.8
24	0240	0240	0254	0254	61	43.5	42.86	54	65	33	4.8	8.0*	16*	0.8
25	0250	0250	-	0254	61	43.5	42.86	54	65	33	4.8	8.0*	16*	0.8
28	0280	0280	0285	0317	67	51.5	50.80	61	73	36	8.0	11.0	15	1.6
30	0300	0300	0317	0349	70	55.0	53.98	68	75	37	8.0	11.0	16	1.6
32	0320	0320	-	0349	70	55.0	53.98	68	75	37	8.0	11.0	16	1.6
33	0330	0330	0349	0381	73	58.0	57.15	71	78	38	8.0	11.0	16	1.6
35	0350	0350	-	0381	73	58.0	57.15	71	78	38	8.0	11.0	16	1.6
38	0380	0380	0381	0412	76	64.5	63.50	77	79	38	8.0	11.0	18	1.6
40	0400	0400	0412	0444	80	67.5	66.68	80	83	40	8.0	11.0	18	1.6
43	0430	0430	0444	0476	83	71.0	69.85	83	86	40	8.0	11.0	19	1.6
45	0450	0450	-	0476	83	71.0	69.85	83	86	40	8.0	11.0	19	1.6
-	-	-	0476	0508	86	74.0	73.03	90	91	43	8.0	11.0	19	1.6
48	0480	0480	0508	0539	89	80.0	79.38	96	92	43	9.5	14.3	19	1.6
50	0500	0500	-	0539	89	80.0	79.38	96	92	43	9.5	14.3	19	1.6
53	0530	0530	0539	0571	103	83.5	82.55	99	105	53	9.5	14.3	19	1.6
55	0550	0550	0571	0603	107	86.5	85.73	102	110	53	9.5	14.3	19	1.6
58	0580	0580	0603	0635	110	89.5	88.90	106	113	53	9.5	14.3	20	1.6
60	0600	0600	-	0635	110	89.5	88.90	106	113	53	9.5	14.3	20	1.6
63	0630	0630	0635	0666	113	93.0	92.08	109	116	53	9.5	14.3	22	1.6
65	0650	0650	0666	0698	116	96.0	95.25	112	119	53	9.5	14.3	22	1.6
68	0680	0680	0698	0730	118	99.0	98.43	115	122	53	9.5	14.3	24	1.6
70	0700	0700	-	0730	118	99.0	98.43	115	122	53	9.5	14.3	24	1.6
-	-	-	0730	0762	122	102.5	101.60	118	126	53	9.5	14.3	24	1.6
75	0750	0750	0762	0793	126	104.0	103.17	120	126	53	9.5	14.3	25	1.6

† Consult your John Crane Sales/Service Engineer.

If the recommended L23 clamp plate dimension is exceeded, or if L23 is greater than L6 + L10, the clamp plate must be recessed as shown under Specifications to L23 thickness and diameter D3 + 3mm so that it is not proud of the seat face to ensure adequate clearance of the seal even after wear has occurred.

To ensure a minimum clearance around the seal head, no part of the clamp plate nuts/bolts should come within ØD3 + 6.

To prevent bowing of the clamp plate, the P.C.D. of the fixing bolts should not exceed the seat outside diameter by more than two fixing bolt diameters. Bolts must be provided with clearance holes.

*VM Seats

Type 10T and 10R Typical Arrangement

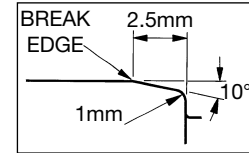
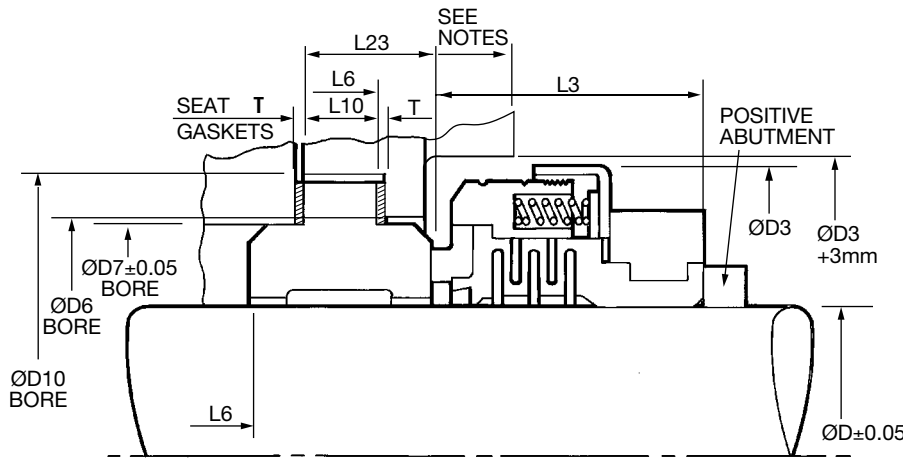

For ease of installation, the lead-in edge of the shaft or sleeve should be chamfered as shown.

D19=DIA. OF SWING OF CLAMP SCREWS

Type 10T and 10R Dimensional Data -Large Sizes (mm)

D (mm)	Seal Size Code (Metric)	D (Inch)	Seal Size Code (Inch)	Seat Size Code	D3	D6	D7	D10	D19	L3	L6	L10	L23	T
80	0800	3.250	0825	0889	150	115.0	114.30	131	164	73	6.4	12.7	27	1.6
85	0850	3.50	0889	0889	156	121.5	120.65	137	170	73	6.4	12.7	28	1.6
90	09700	3.750	0952	1016	163	128.0	127.00	144	177	73	6.4	12.7	30	1.6
95	0950	-	-	1016	163	128.0	127.00	144	177	73	6.4	12.7	30	1.6
100	1000	4.000	1016	1079	169	137.5	136.53	153	183	73	6.4	12.7	39	1.6

Notes: Type 10T and 10R seals can be supplied up to 165mm/6.500 in diameter. For diameters over 100mm/4.000in. consult your John Crane representative.

† Consult your John Crane representative.

If the recommended L23 clamp plate dimension is exceeded, or if L23 is greater than L6 + L10, the clamp plate must be recessed as shown under specifications to L23 thickness and diameter D3 + 3mm so that it is not proud of the seat face to ensure adequate clearance of the seal even after wear has occurred.

To ensure a minimum clearance around the seal head, no part of the clamp plate nuts/bolts should come within ØD3 + 6

To prevent bowing of the clamp plate, the P.C.D. of the fixing bolts should not exceed the seat outside diameter by more than two fixing bolt diameters. Bolts must be provided with clearance holes.

Positive Abutment

It is recommended that a positive abutment is always provided at the back of the bellows. The outside diameter of the abutment ring (or shaft shoulder) should be related to the seal size, as follows:

Seal Sizes	Outside Diameter = Shaft Diameter +
16 to 25mm	7.00mm/0.28in.
28 to 76mm	10.00mm/0.40in
82 to 100mm	13.00mm/0.51in.

VM Seat

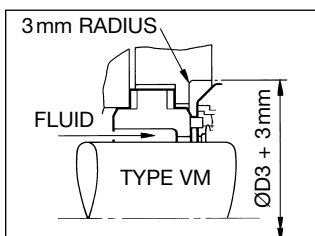

Seat type VM for seal sizes 16 to 25mm/0.750 to 1.000in. is used to promote increased fluid flow to the seal faces.

TYPE 10T/10R

PTFE BELLOWS SEALS

Operating Limits

Pressure		Temperature	Speed
Operating	Static Test		
Refer to Chart 4	20°C/70°F: 11 bar g/150 psig 60°C/140°F: 8 bar g/110 psig 100°C/210°F: 5 bar g/65 psig 120°C/250°F: 3 bar g/40 psig	-45°C to +120°C/ -50°F to +250°F	16 m/s 3,150 fpm and 4,000 rpm Maximum

Pressure/Velocity (PV) Limits

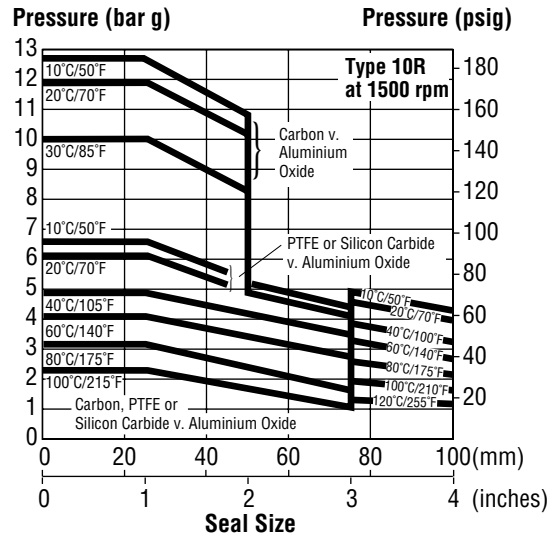
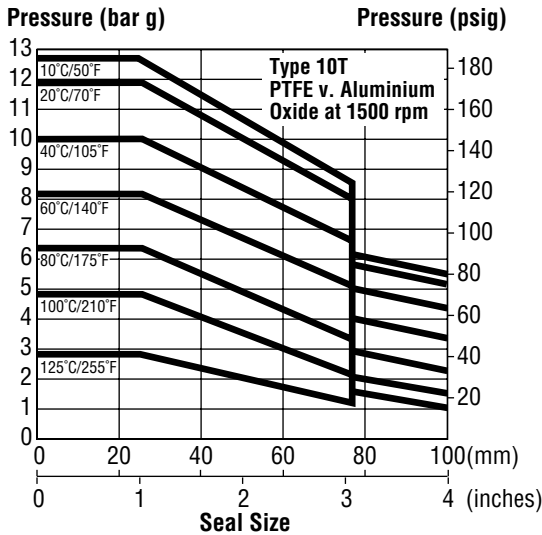

Example for Determining PV Limits:

To determine the maximum operating pressure for the required size of Type 10T or 10R seal, refer directly to the appropriate graph in the charts above. These values are correct at 1,500 rpm.

For shaft speeds other than 1,500 rpm (where these are permissible), multiply the pressure obtained from the graph by a correction factor as follows.

- 1,000 rpm (all seal sizes) x 1.3
- 3,000 rpm (sizes up to 75mm/3in. only) x 0.9
- 4,000 rpm (sizes up to 75mm/3in. only) x 0.8

The maximum operating speed for seals up to 75mm/3in shaft diameter is 4,000 rpm: above 75mm/3in. the limit is 1,500 rpm. Type 10R silicon carbide face inserts must not be used at a velocity greater than 7.5m/s/1,500 fpm.

The operating parameters shown are the recommended limits for continuous operation, and can be exceeded by a reasonable amount for limited periods. If the required performance is outside the specified limits, contact your John Crane representative.

Note: If the seal is required to handle water, e.g., on test or for cleaning, 0.1 percent of a suitable wetting agent should be added.

Material Availability

SEAL COMPONENTS	MATERIALS		
	Description	Standard	Optional
Bellows	Composite PTFE	-	
Gasket	Glass-Filled PTFE	-	
Face Insert	Sintered Silicon Carbide Resin-Impreganted Carbon Graphite		Carbon-Filled PTFE
Thrust Ring (Small) Spring Shroud	Glass-Filled PTFE	-	
Thrust Ring (with Pins) (Large) Thrust Washer (Large) Half Clamp Cap Head Screw Self-Locking Nut	316 Stainless Steel	-	
Support Sleeve (Small)	PTFE-Coated 316 Stainless Steel	-	
'VG' Seat 'VM' Seat	99.5 Percent Aluminium Oxide Ceramic		Sintered Silicon Carbide
Springs (Small Sizes) Springs (Large Sizes)	PVDF Coated 316 Stainless Steel 316 Stainless Steel	-	

Criteria for Installation

Shaft/Sleeve	Limits
Surface Finish	0.8 to 1.2 μm Ra Fine Machined
Ovality/Out of Roundness	0.013 mm/ 0.0005 in.
Dynamic End Play/ Axial Float Allowance	± 0.13 mm/0.005 in.
Shaft Squareness to Housing	Refer to Chart opposite

Seal Guard

It is essential to provide a guard, preferably of transparent material, around the seal to contain any spray leakage. A suitable means of collection should be included for harmful fluids to facilitate drainage and disposal.

Housing Squareness to Shaft

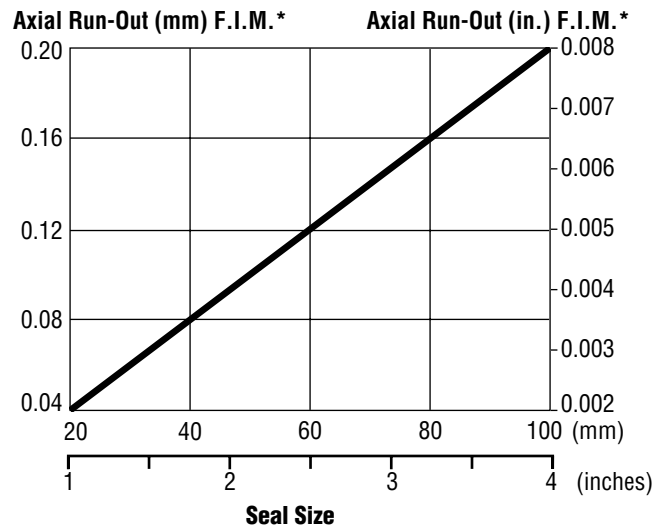

TYPE 10T/10R

PTFE BELLOWS SEALS



North America	Europe	Latin America	Middle East & Africa	Asia Pacific
United States of America	United Kingdom	Brazil	United Arab Emirates	Singapore
Tel: 1-847-967-2400	Tel: 44-1753-224000	Tel: 55-11-3371-2500	Tel: 971-481-27800	Tel: 65-6518-1800
Fax: 1-847-967-3915	Fax: 44-1753-224224	Fax: 55-11-3371-2599	Fax: 971-488-62830	Fax: 65-6518-1803

If the products featured will be used in a potentially dangerous and/or hazardous process, your John Crane representative should be consulted prior to their selection and use. In the interest of continuous development, John Crane Companies reserve the right to alter designs and specifications without prior notice. It is dangerous to smoke while handling products made from PTFE. Old and new PTFE products must not be incinerated. ISO 9001 and ISO14001 Certified, details available on request.